



IP 67
ACCORDING TO
EN 60529:1991+A1:2001
IEC 60529:2001



SPECIFICATIONS

MECHANICAL LIFE: 40,000 make-and-break cycles.

CONTACT RATING: 0.4 VA max. @ 20 V AC or DC max.

CONTACT RESISTANCE: Below 100 mΩ typ. initial @ 2-4 V DC, 100 mA.

INSULATION RESISTANCE: 500 MΩ min.

DIELECTRIC STRENGTH: 500 Vrms min. @ sea level.

OPERATING TEMPERATURE: -30°C to 85°C

MATERIALS

HOUSING AND BASE: Glass filled nylon 6/6 or 4/6, flame retardant, heat stabilized (UL94V-0)

ACTUATOR: Glass filled nylon 6/6, flame retardant, heat stabilized (UL94V-0), with standard internal o-ring seal.

SWITCH SUPPORT: Steel, with Sn plated.

CONTACT: Phosphor bronze, Gold plated.

TERMINALS: Brass, Gold plated.

HOW TO ORDER

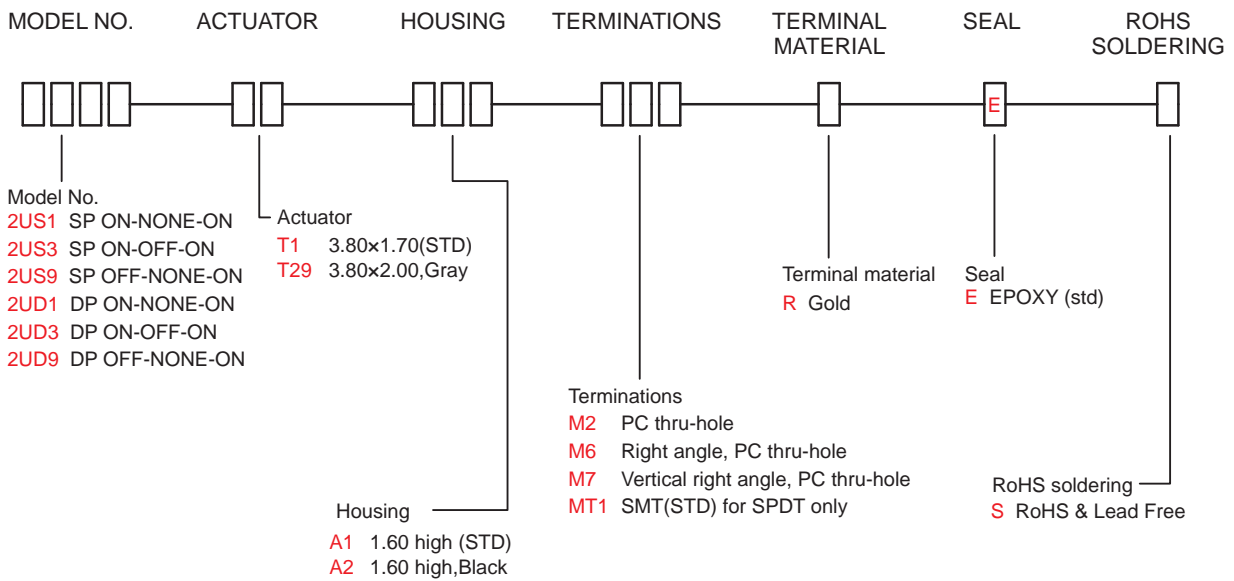

NOTE: T29A2 type only for 2US1/2US3/2UD1/2UD3 function

2U Series

Sealed Ultraminiature Toggle Switches

SWITCH FUNCTION

NO. POLES	MODEL NO.	SWITCH FUNCTION			CONNECTED TERMINALS / SCHEMATIC		
		POS.1	POS.2	POS.3	POS.1	POS.2	POS.3
SP	2US1	ON	NONE	ON	5-6	N/A	5-4
	2US3	ON	OFF	ON		OPEN	
	2US9	OFF	NONE	ON	OPEN	N/A	4-6
DP	2UD1	ON	NONE	ON	2-3,5-6	N/A	2-1,5-4
	2UD3	ON	OFF	ON		OPEN	
	2UD9	OFF	NONE	ON	OPEN	N/A	

POLE OPTIONS

M2

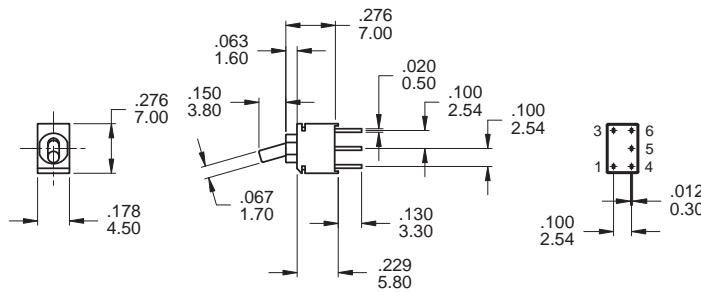

P.C. MOUNTING

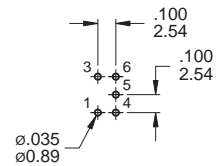

SPDT

Part No. Shown : 2US1T1A1M2RES

M2

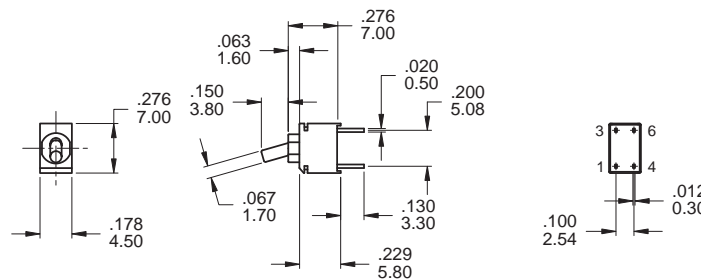

P.C. MOUNTING

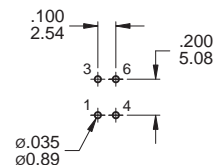

SPDT

Part No. Shown : 2US9T1A1M2RES

M2

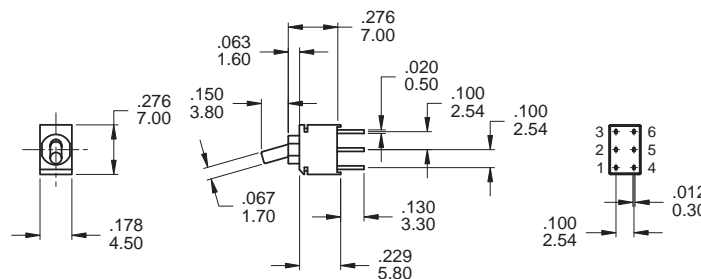

P.C. MOUNTING

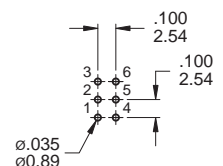

DPDT

Part No. Shown : 2UD1T1A1M2RES

2U Toggle Switches

M6

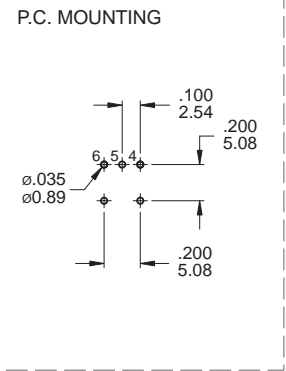
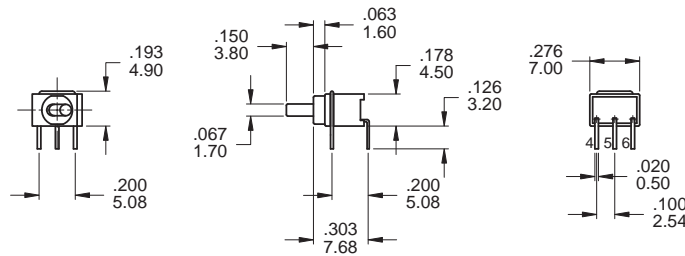

SPDT

Part No. Shown : 2US1T1A1M6RES

M6

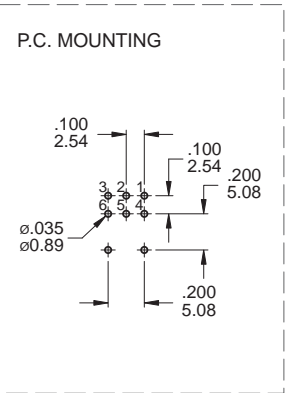
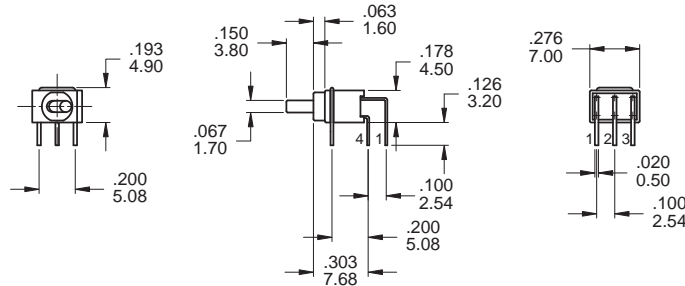

DPDT

Part No. Shown : 2UD1T1A1M6RES

M7

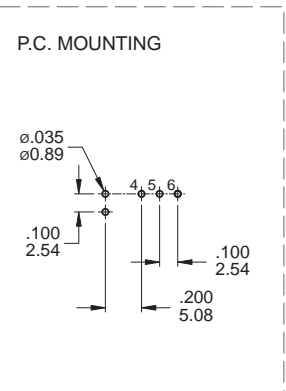
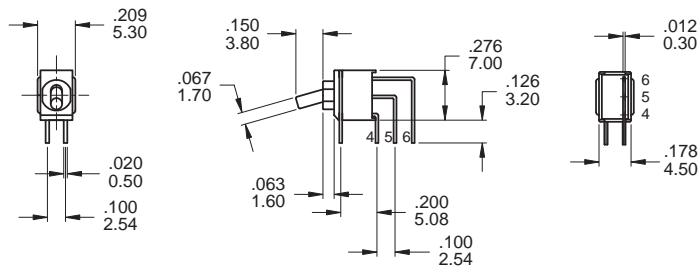

SPDT

Part No. Shown : 2US1T1A1M7RES

M7

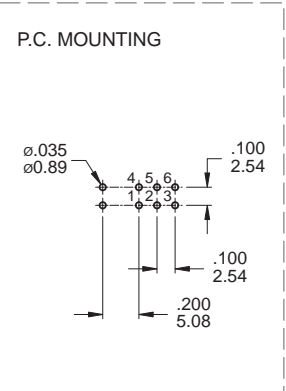
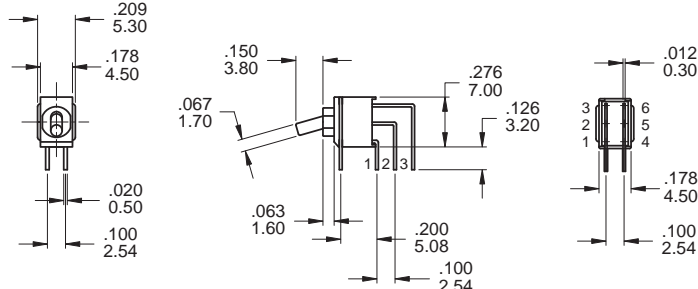
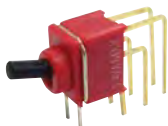

DPDT

Part No. Shown : 2UD1T1A1M7RES



2U
Toggle Switches

2U Series

Sealed Ultraminiature Toggle Switches

* T29A2 type only for 2US1/2US3/2UD1/2UD3 function

M2

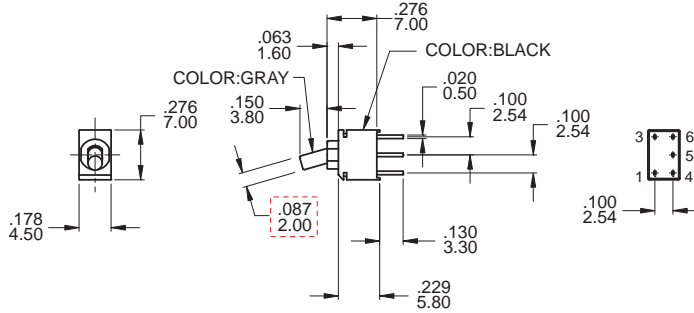

P.C. MOUNTING

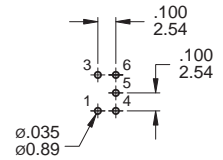

SPDT

Part No. Shown : 2US1T29A2M2RES

M6

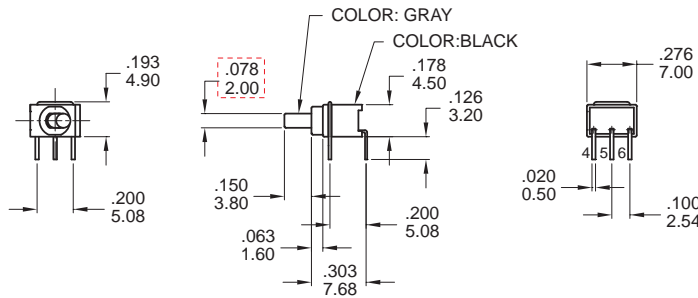

P.C. MOUNTING

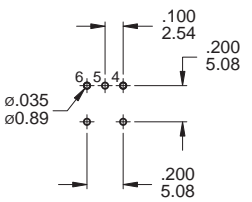

SPDT

Part No. Shown : 2US1T29A2M6RES

MT1

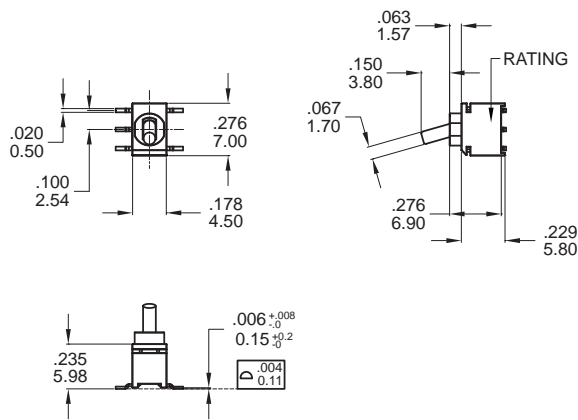

P.C. MOUNTING

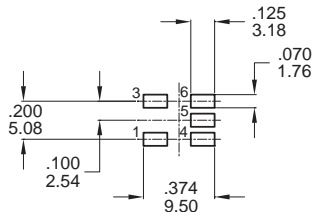

SPDT

Part No. Shown : 2US1T1A1MT1RES

SOLDERING PROCESSES

WAVE SOLDERING:

Recommended Soldering Temperature: $270 \pm 5^{\circ}\text{C}$

Duration of Solder Immersion: Max 5 sec. (PCB is 1.6mm in thickness)