

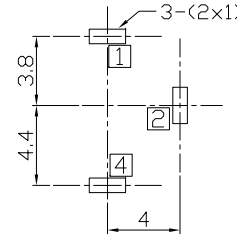

RoHS Compliant
2002/95/EC

REV.	ECN. NO.	APPD.

DIMENSIONS

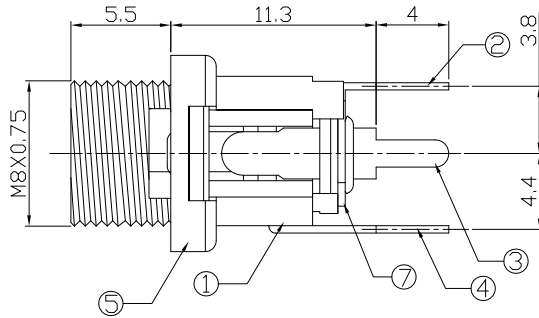
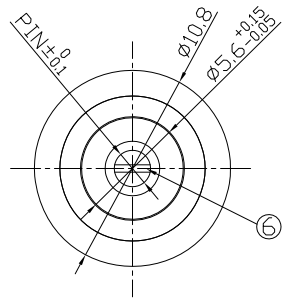

RECOMMENDED P.C.B. LAYOUT
UNSPECIFIED TOLERANCE:±0.05
(BOTTOM VIEW)

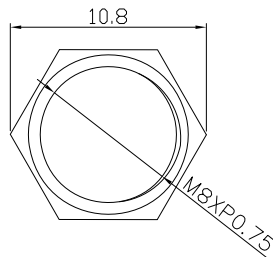
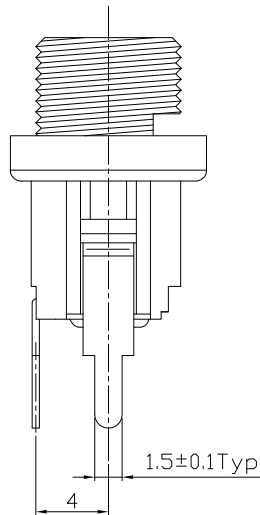

Nut

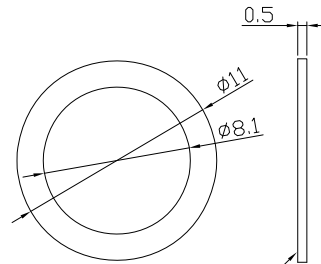
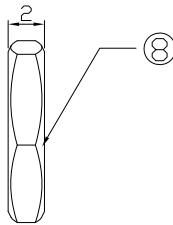

Washer

MODEL CODE:

DCB0-0026M- A □ PB BK C 0 4

- (1) (2) (3)(4) (5) (6) (7)(8) (9)
- (1):Series type:DIP DC POWER JACK.
- (2):Series No.
- (3):Schematic option: A , B
- (4):Center pin diameter:
H=Ø2.0 , I=Ø2.35 , J=Ø2.5
- (5):Material of housing:
PB=PBT
- (6):Housing color:
BK=Black
- (7):Terminal plating
C=copper&tin alloy plating
- (8):Special option:
0=No special option
- (9):Packing mode:
4=Bag packing

SPECIFICATION:

- 1.Rating : DC 30V 0.5A;
- 2.Contact resistance: ≤30mΩ;
After test:≤50mΩ
- 3.Insulation resistance: ≥100MΩ (DC500V);
After test:≥50MΩ
- 4.Withstand voltage: 500VAC ;
- 5.Insertion and extraction force: 3-30N;
- 6.life test: 5,000 cycles;
- 7.Operation temperature range:-20°C~70°C;
- 8.Preservative temperature range:-40°C~85°C;

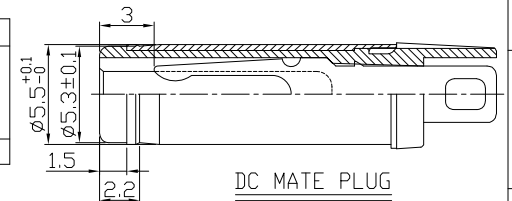
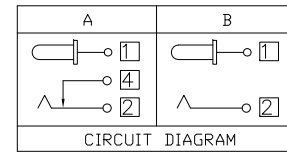

DC MATE PLUG

Model No.	H	I	J
CENTER PIN	Ø2.0	Ø2.35	Ø2.5

○: ITEM NO. □: TERMINAL NO.

NO.	PARTS	MATERIAL	Q'TY	FINISHING
⑨	Washer-2	Spcc	1	Nickel plating
⑧	Nut	Copper alloy	1	Nickel plating
⑦	Washer-1	Bakelite	2	
⑥	Pin	Copper alloy	1	Nickel plating
⑤	Bushing	Copper alloy	1	Nickel plating
④	Shunt Terminal ④	Brass	1	Copper&tin plating
③	Tip Spring ②	Phosphor bronze	1	Copper&tin plating
②	Center pin terminal ①	Brass	1	Copper&tin plating
①	Housing	PBT	1	Black

THESE DRAWINGS AND SPECIFICATIONS ARE THE PROPERTY OF ACCURATE INNOTECH INC AND SHALL NOT BE REPRODUCED, COPIED OR USED IN ANY MANNER WITHOUT THE PRIOR WRITTEN CONSENT OF ACCURATE INNOTECH INC.

TOLERANCE	ANGLES	UNITS	雅安科技有限公司 ACCURATE INNOTECH INC.			
±0.3	±2°	mm	TITLE: DIP DC POWER JACK		PART NO.: DCB0-0026M	
		MAT'L	DR: Ricky 2019/04/10		DWG NO.: AB0-0026M	
		SEE NOTE	CHKD: Ricky 2019/04/10			
		FINISH	APPD:			
		SEE NOTE			SCALE	SHEET
		Q'TY			1:1	1/1
					REV.	CUSTOMER
					A	DRAWING