

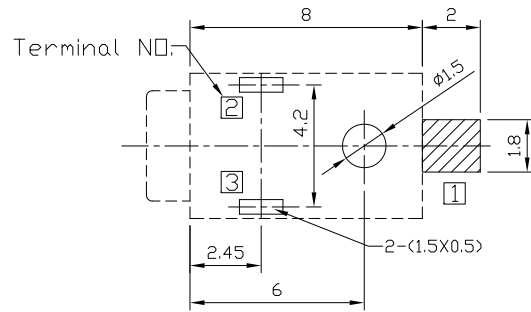

RoHS
Compliant
2002/95/EC

REV.	ECN. NO.	APPD.

DIMENSIONS

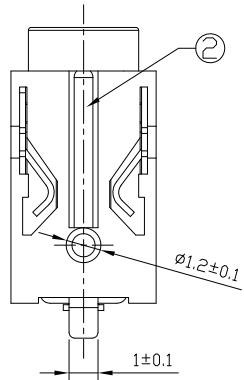
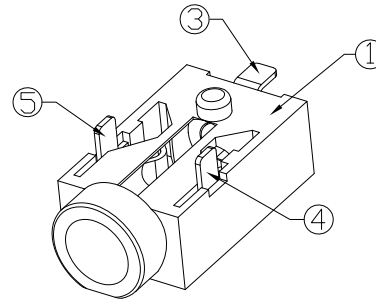
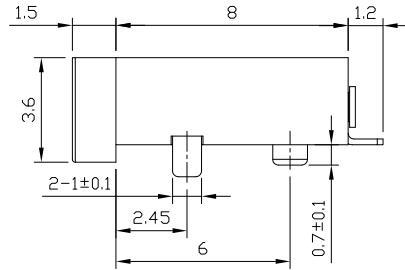
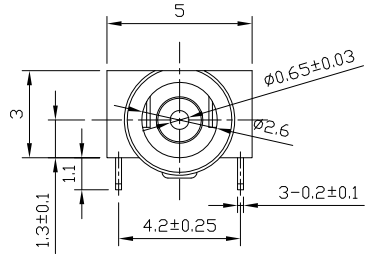

P.C.B Layout (Top view)

MODEL CODE:

DCB0-00550- D A 9T BK S 0 1

- (1) (2) (3)(4)(5) (6)(7)(8) (9)
- (1):Series type:SMD DC POWER JACK.
 (2):Series No.
 (3):Schematic option: D
 (4):Center pin diameter:
 A=Ø0.65
 (5):Material of housing:
 9T=PA9T(Standard)
 (6):Housing color:
 BK=Black, 9C=White(0419)
 (7):Terminal plating:
 S=Silver(Ag)
 (8):Special option:
 0=No special option
 (9):Packing mode:
 1=Reel packing
 4=Bag packing

SPECIFICATION

- Rating : DC 12V 2A;
- Contact resistance: ≤30mΩ;
- Insulation resistance: ≥100MΩ (DC500V);
- Withstand voltage: 500VAC ;
- Insertion and extraction force: 3-30N;
- life test: 5,000 cycles;
- Operation temperature range:-20°C~70°C;
- Preservative temperature range:-40°C~85°C;

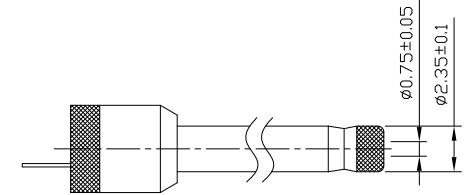
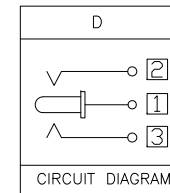

DC MATE PLUG

○: ITEM NO. □: TERMINAL NO.

NO.	PARTS	MATERIAL	Q'TY	FINISHING	TOLERANCE	ANGLES	UNITS
5	Tip spring 3	Beryllium bronze	1	Silver plating	±0.3	±2°	mm
4	Tip spring 2	Beryllium bronze	1	Silver plating			MAT'L
3	Center pin terminal 1	Brass	1	Silver plating			SEE NOTE
2	Center pin 1	Brass	1	Silver plating			FINISH
1	Housing	PA9T	1				SEE NOTE
					<small>THESE DRAWINGS AND SPECIFICATIONS ARE THE PROPERTY OF ACCURATE INNOTECH INC AND SHALL NOT BE REPRODUCED, COPIED OR USED IN ANY MANNER WITHOUT THE PRIOR WRITTEN CONSENT OF ACCURATE INNOTECH INC.</small>		
							Q'TY

雅安科技有限公司
ACCURATE INNOTECH INC.

TITLE: SMD DC POWER JACK	PART NO.: DCB0-00550
DR: Ricky 2018/06/22	DWG NO.: AB0-00550
CHKD: Ricky 2018/06/22	SCALE SHEET REV. CUSTOMER 1:1 1/1 A DRAWING
APPD:	