

REV	LTR	DESCRIPTION	DATE	REVISER	APPD

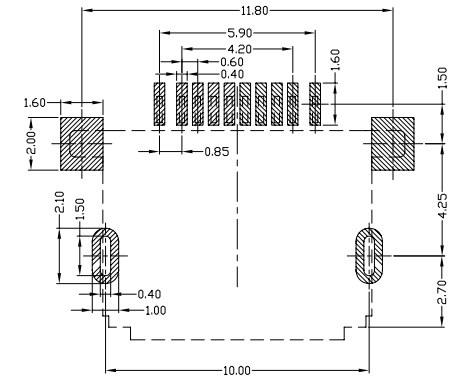

RECOMMENDED PCB LAYOUT

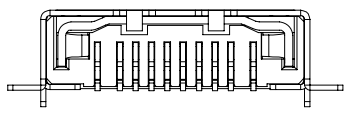
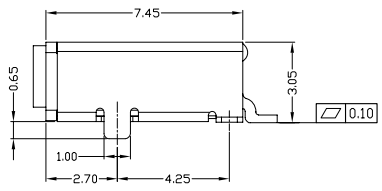
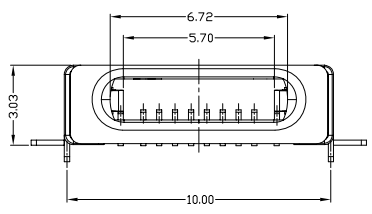
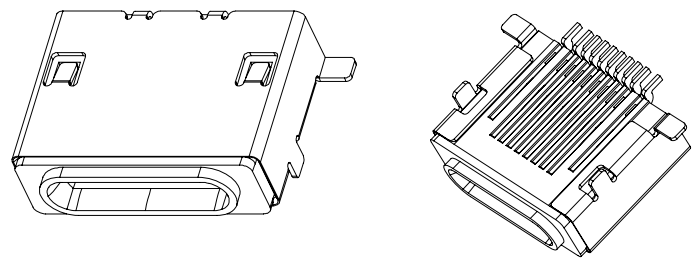
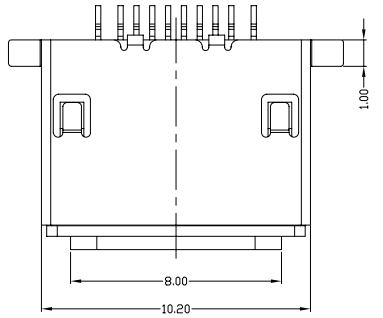
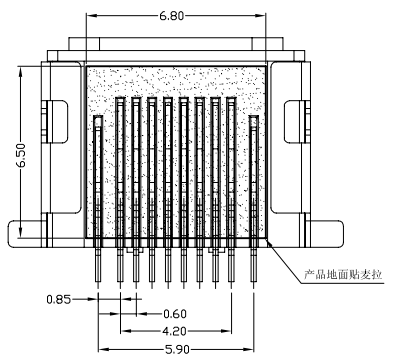

PIN NO.	SIGNAL
PIN 1#	DETECT1
PIN 2#	SCC1
PIN 3#	DP1
PIN 4#	DN1
PIN 5#	PWR A
PIN 6#	PWR B
PIN 7#	DN2
PIN 8#	DP2
PIN 9#	ACC2
PIN 10#	DETECT2
SHELL	GND

NOTES:

- ELECTRICAL:
 - CURRENT RATING: 1.0AMP;
 - INSULATION RESISTANCE: 100MΩ MIN;
 - CONTACT RESISTANCE: 50mΩ MAX;
 - WITHSTANDING VOLTAGE: 100V AC;
 - OPERATING TEMPERATURE: -30°C TO +80°C.
- Mechanical:
 - Mating Force: 35N MAX
 - Unmating Force: 3N MIN.
- NOTE: 1. DIMENSIONS MARKED "▼" TO BE CHECKED BY Q.C & IPQC.

4. PART NO.

IPNF-101T-4BVS10
 1:Au 1U*
 6:Au 30U*
 T:TIN
 N:NICKEL
 W:WHITE
 B:BLACK
 1:PBT
 2:PA6T
 3:PA9T
 4:LCP

Bill of materials:

NO	PARTS	MATERIAL	QTY	FINISHING	UNITS	mm	雅安科技有限公司 ACCURATE INNOTECH INC.						
3	HOUSING	LCP UL94-V0	1	UL94V-0	X. ±0.35	X.* ±2'	MAT'L	TITLE: iPhone 5 10P母座		PART NO.: IPNF-101T-4BVS10			
2	SHELL	STAINLESS STEEL	1	PLATED TIN	.X ±0.3	.X* ±1'	SEE NOTE	DR: gan 2014/06/18		DWG NO.: AII-S10			
1	TERMINAL	COPPER ALLOY	10	PLATED GOLD/TIN	.XX ±0.25	.XX*	FINISH	CHKD: gan 2014/06/18		SCALE SHEET REV. CUSTOMER DRAWING			
					.XXX ±0.15	.XXX*	SEE NOTE	APPD:		1:1	1/1	B	

THESE DRAWINGS AND SPECIFICATIONS ARE THE PROPERTY OF ACCURATE INNOTECH INC AND SHALL NOT BE REPRODUCED, COPIED OR USED IN ANY MANNER WITHOUT THE PRIOR WRITTEN CONSENT OF ACCURATE INNOTECH INC.

