

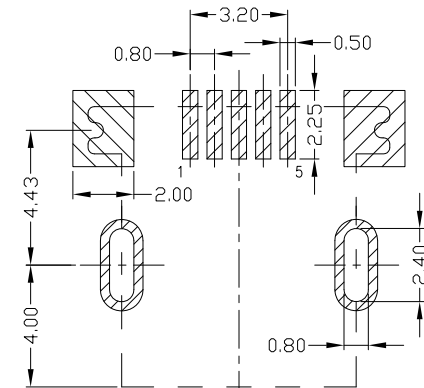

RoHS
Compliant
2002/95/EC

REV	LTR	DESCRIPTION	DATE	REVISER	APPD

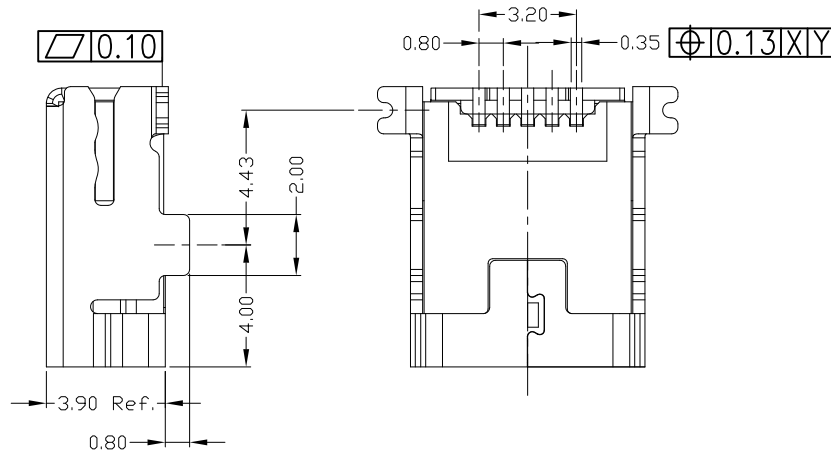
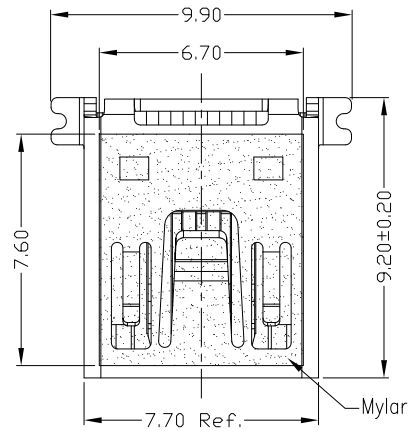
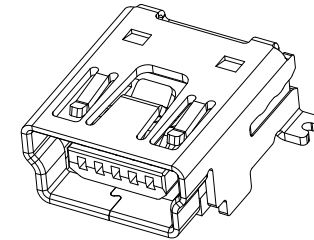
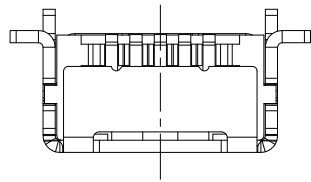

RECOMMENDED P.C.B LAYOUT

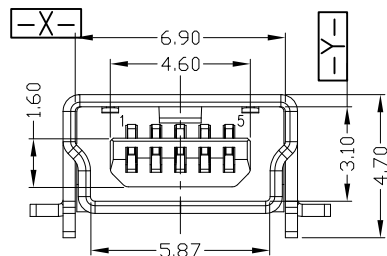

NOTES:

- ELECTRICAL:
 - VOLTAGE CURRENT RATING: 1.0AMP,30V AC;
 - INSULATION RESISTANCE: 100MΩ MIN;
 - CONTACT RESISTANCE: 50mΩ MAX;
 - WITHSTANDING VOLTAGE: 300V AC;
 - OPERATING TEMPERATURE: -25°C TO +85°C.
- Mechanical:
 - Mating Force: 35N MAX
 - Unmating Force: 7N MIN.
- DIMENSIONS MARKED "▼" TO BE CHECKED BY Q.C & IPQC.

4. PART NO.

MUBF-05*N-4BHUA151-M

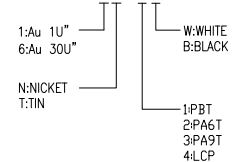

Bill of materials:

NO	PARTS	MATERIAL	QTY	FINISHING	UNITS	mm	TITLE:	PART NO.:			
5				.X ±0.15	Ang1°		雅安科技有限公司				
4				.XX ±0.10			ACCURATE INNOTECH INC.				
3	SHELL	COPPER ALLOY	1	PLATED NICKEL/TIN		SEE NOTE	MINI USB 5P F SMT B Type	MUBF-05XN-4BHUA151-M			
2	HOUSING	LCP+30%GF	1	UL94V-0		SEE NOTE	前插后贴无柱贴麦拉				
1	TERMINAL	COPPER ALLOY	5	PLATED GOLD/TIN			DR: Ricky 2017/10/06	AWG NO.: AII-HUA151			
<small>THESE DRAWINGS AND SPECIFICATIONS ARE THE PROPERTY OF ACCURATE INNOTECH INC AND SHALL NOT BE REPRODUCED, COPIED OR USED IN ANY MANNER WITHOUT THE PRIOR WRITTEN CONSENT OF ACCURATE INNOTECH INC</small>							CHKD: Ricky 2017/10/06	SCALE	SHEET	REV.	CUSTOMER
							APPD:	4:1	1/1	B	DRAWING