

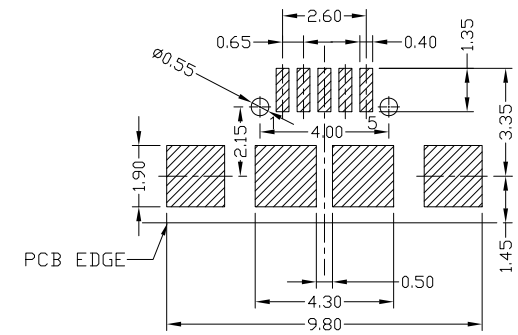

RoHS Compliant
2002/95/EC

Halogen Free

REV.	ECN. NO.	APPD.

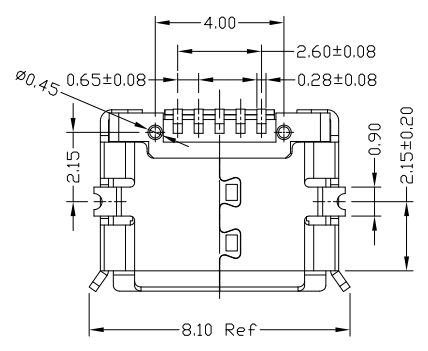
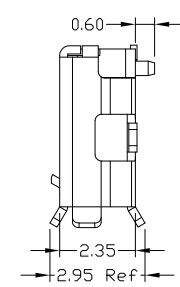
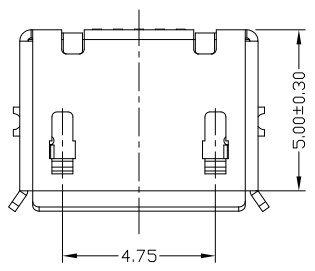
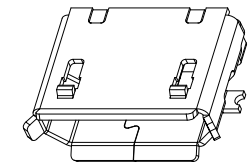
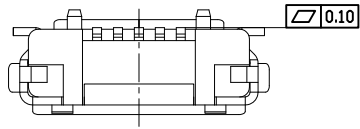

RECOMMENDED PCB LAYOUT

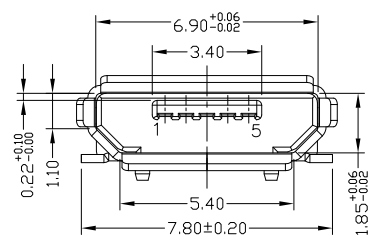

- NOTES:
- ELECTRICAL:
 - VOLTAGE CURRENT RATING: PIN1&5 1.8AMP MAX / PIN2&3&4 1AMP MAX. ,30V AC;
 - INSULATION RESISTANCE: 100MΩ MIN;
 - CONTACT RESISTANCE: 30mΩ MAX;
 - WITHSTANDING VOLTAGE: 100V AC; FOR 1 MIN.
 - OPERATING TEMPERATURE: -30°C TO +80°C.
 - Mechanical:
 - Mating Force: 35N MAX
 - Unmating Force: 10N MIN.
 - DIMENSIONS MARKED "▼" TO BE CHECKED BY Q.C & IPQC.

- 4.PART NO.
MUYF-05*T-4BHUA014
- 1:Au 1U*
6:Au 30U*T:TIN
N:NICKEL
- W:WHITE
B:BLACK
1:PBT
2:PA6T
3:PA9T
4:LCP

Bill of materials:

NO	PARTS	MATERIAL	QTY	FINISHING	UNITS	mm	TITLE:	PART NO.:
3	SHELL	COPPER ALLOY	1	PLATED TIN	X. ±0.35	X.* ±2*	MICRO USB B TYPE F 5P SMT 有脚柱	MUYF-05*T-4BHUA014
2	HOUSING	LCP+30%GF	1	UL94V-0	.X ±0.30	.X* ±1*	DR: Ricky 2018/5/8	DWG NO.:
1	TERMINAL	COPPER ALLOY	5	PLATED GOLD	.XX ±0.25	.XX*	CHKD: Ricky 2018/5/8	AII-HUA014
					.XXX ±0.15	.XXX*	APPD:	SCALE SHEET REV. CUSTOMER DRAWING

THESE DRAWINGS AND SPECIFICATIONS ARE THE PROPERTY OF ACCURATE INNOTECH AND SHALL NOT BE REPRODUCED, COPIED OR USED IN ANY MANNER WITHOUT THE PRIOR WRITTEN CONSENT OF ACCURATE INNOTECH INC

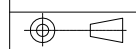

雅安科技有限公司
ACCURATE INNOTECH INC.

SCALE: 5:1
SHEET: 1/1
REV: A
CUSTOMER DRAWING