

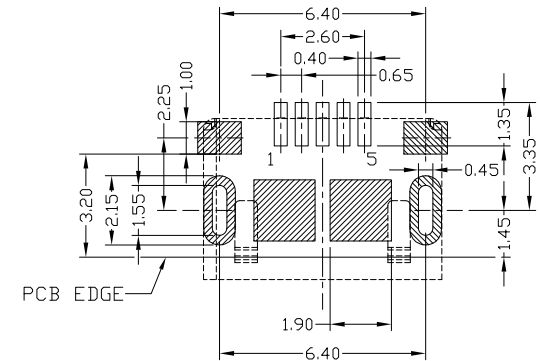

RoHS  
Compliant  
2002/95/EC

Halogen Free

REV.	ECN. NO.	APPD.

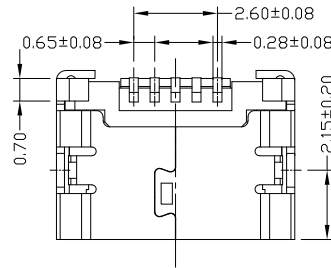
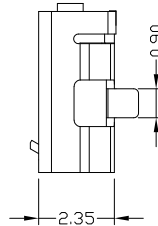
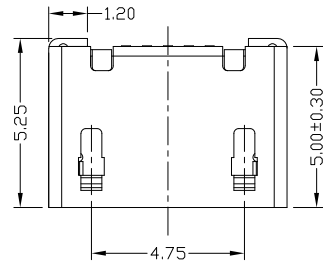
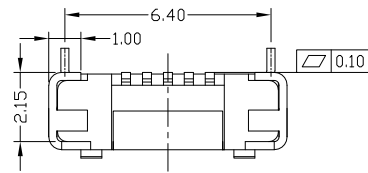

RECOMMENDED PCB LAYOUT

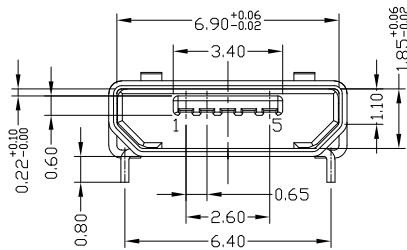

NOTES:

- ELECTRICAL:
  - VOLTAGE CURRENT RATING: PIN1&5 1.8AMP MAX / PIN2&3&4 1AMP MAX. ,30V AC;
  - INSULATION RESISTANCE: 100MΩ MIN;
  - CONTACT RESISTANCE: 30mΩ MAX;
  - WITHSTANDING VOLTAGE: 100V AC; FOR 1 MIN.
  - OPERATING TEMPERATURE: -30°C TO +80°C.
- Mechanical:
  - Mating Force: 35N MAX
  - Unmating Force: 10N MIN.
- DIMENSIONS MARKED "▼" TO BE CHECKED BY Q.C & IPQC.

4.PART NO.

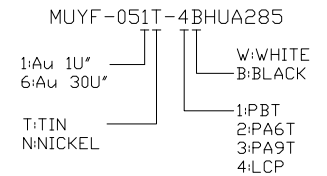

Bill of materials:

3	SHELL	COPPER ALLOY / STAINLESS STEEL	1	PLATED TIN	.X	±0.15	.X'	±1*	UNITS	mm	
					.XX	±0.10	.XX'		MAT'L		
2	HOUSING	LCP+30%GF	1	UL94V-0	.XXX	±0.05	.XXX'		SEE NOTE		
									FINISH		
1	TERMINAL	COPPER ALLOY	5	PLATED GOLD				SEE NOTE			
NO	PARTS	MATERIAL	QTY	FINISHING	THESE DRAWINGS AND SPECIFICATIONS ARE THE PROPERTY OF ACCURATE INNOTECH INC AND SHALL NOT BE REPRODUCED, COPIED OR USED IN ANY MANNER WITHOUT THE PRIOR WRITTEN CONSENT OF ACCURATE INNOTECH INC					Q'TY	

雅安科技有限公司  
ACCURATE INNOTECH INC.

TITLE:	MICRO USB B TYPE F 5P 插板 6.4脚长0.8 有焊脚无柱无导位	PART NO.:	MUYF-05XT-4BHUA285
DR:	Ricky 2022/09/26	DWG NO.:	AII-HUA285
CHKD:	Ricky 2022/09/26	SCALE	5:1
APPD:		SHEET	1/1
		REV.	A
		CUSTOMER DRAWING	