

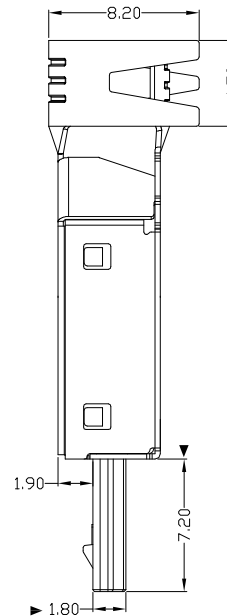

RoHS  
Compliant  
2002/95/EC

REV	LTR	DESCRIPTION	DATE	REVISER	APPD

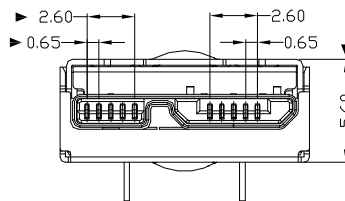
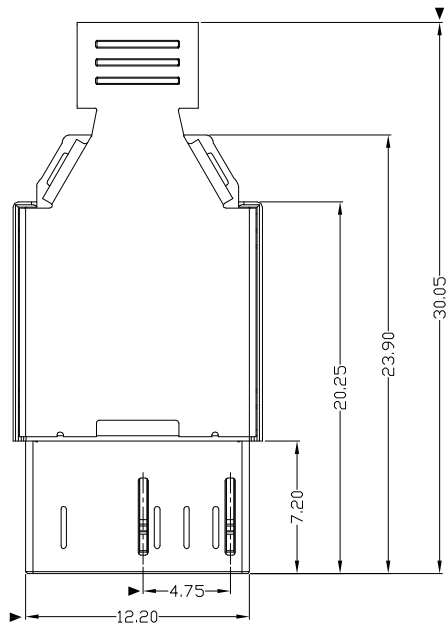
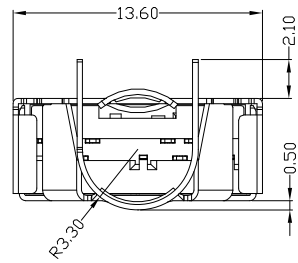

NOTES:

- ELECTRICAL:
  - VOLTAGE CURRENT RATING: 1AMP, 30V AC;
  - INSULATION RESISTANCE: 100MΩ MIN;
  - CONTACT RESISTANCE: 30mΩ MAX;
  - WITHSTANDING VOLTAGE: 500V AC;
  - OPERATING TEMPERATURE: -40°C TO +85°C.
- Mechanical:
  - Mating Force: 35N MAX
  - Unmating Force: 10N MIN.
- NOTE: 1. DIMENSIONS MARKED "▼" TO BE CHECKED BY Q.C & IPQC.
- PART NO.

MUYM-105N-4BSS12

W/WHITE  
B/BLACK  
1Au 1U'  
5Au 15U'  
6Au 30U'  
1PBT  
2PA6T  
3PA9T  
4LCP

Bill of materials:

NO	PARTS	MATERIAL	QTY	FINISHING									
5	HOOK	STAINLESS STEEL	1	PLATED NICKEL	X. ±0.35	X.' ±2'	UNITS	mm	<p style="text-align: center;"><b>雅安科技有限公司</b> <b>ACCURATE INNOTECH INC.</b></p> <p>TITLE: Micro USB 3.0 B TYPE MALE (半封槽) PART NO.: MUYM-105N-4BSS12</p> <p>DR: gan 2012/8/3 DWG NO.: AII-SS12</p> <p>CHKD: gan 2012/8/3 SCALE: 1:1 SHEET: 1/1 REV: B CUSTOMER DRAWING</p>				
4	SHELL	SPCC	1	PLATED NICKEL	.X ±0.3	.X' ±1'	MAT'L	SEE NOTE					
3	HOUSING SHELL	COPPER ALLOY	1	PLATED NICKEL	.XX ±0.25	.XX'	FINISH	SEE NOTE					
2	HOUSING	LCP/PBT	1	UL94V-0	.XXX ±0.15	.XXX'	Q'TY	SEE NOTE					
1	TERMINAL	COPPER ALLOY	10	PLATED GOLD/TIN									
					<small>THESE DRAWINGS AND SPECIFICATIONS ARE THE PROPERTY OF ACCURATE INNOTECH INC AND SHALL NOT BE REPRODUCED, COPIED OR USED IN ANY MANNER WITHOUT THE PRIOR WRITTEN CONSENT OF ACCURATE INNOTECH INC</small>								



RoHS  
Compliant  
2002/95/EC

REV	LTR	DESCRIPTION	DATE	REVISER	APPD

A

B

C

D

E

A

B

C

D

E

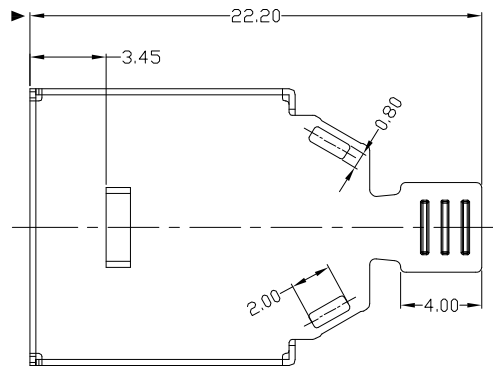
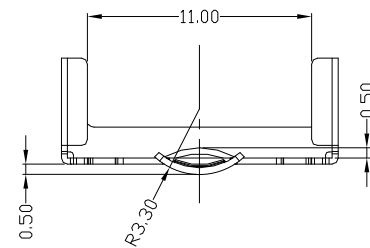
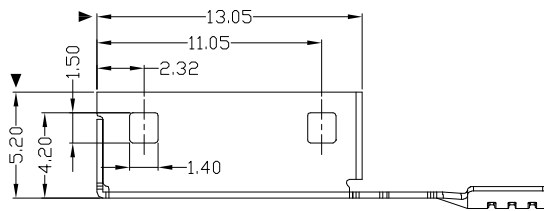
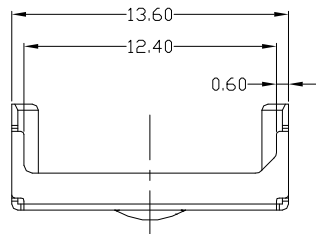
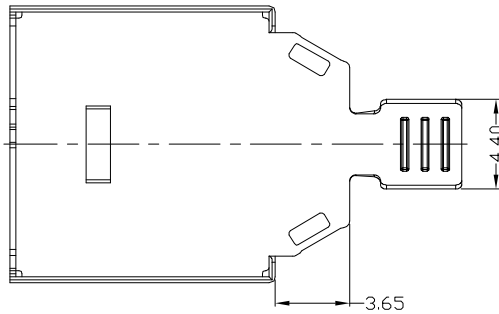

NOTES:

1. Material:

Shell: SPCC Plating Ni

2. NOTE: DIMENSIONS MARKED "▼" TO BE CHECKED BY Q.C & IPQC.

X. ±0.35	X.' ±2'	UNITS	雅安科技有限公司 ACCURATE INNOTECH INC.			
.X ±0.3	.X' ±1'	MAT'L	TITLE: Micro USB 3.0 B TYPE MALE (半封槽) Bottom Shell			
.XX ±0.25	.XX'	SEE NOTE	DR: gan 2012/8/3		PART NO.: MUYM-105N-4BSS12	
.XXX ±0.15	.XXX'	FINISH	CHKD: gan 2012/8/3		DWG NO.: AII-SS12	
THESE DRAWINGS AND SPECIFICATIONS ARE THE PROPERTY OF ACCURATE INNOTECH INC. AND SHALL NOT BE REPRODUCED, COPIED OR USED IN ANY MANNER WITHOUT THE PRIOR WRITTEN CONSENT OF ACCURATE INNOTECH INC.		Q'TY	APPD:		SCALE	SHEET
					1:1	1/1
					REV.	CUSTOMER DRAWING
					B	

1

2

3

4

5

6

7



RoHS  
Compliant  
2002/95/EC

REV	LTR	DESCRIPTION	DATE	REVISER	APPD

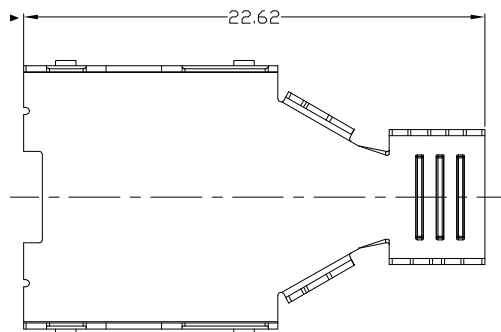
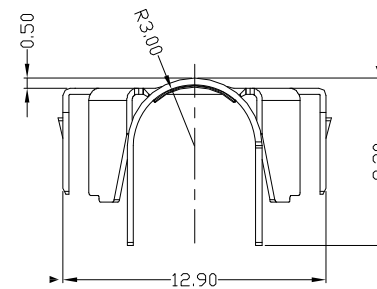
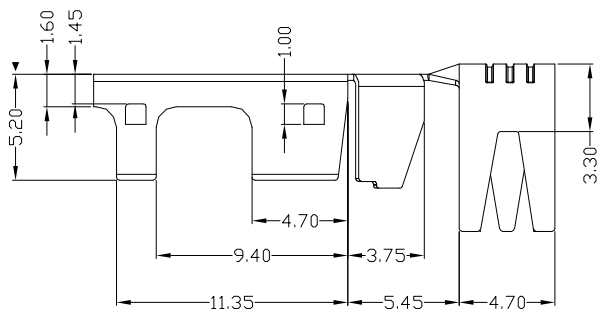
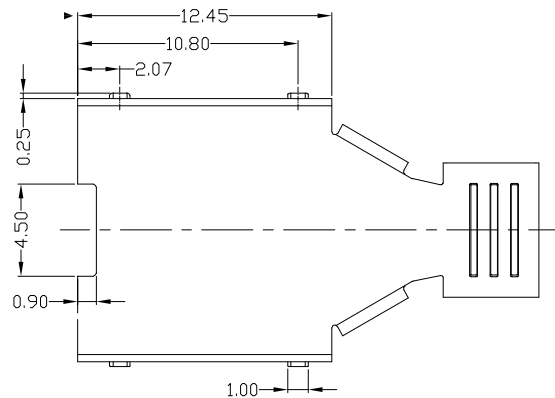

NOTES:  
1. Material:  
Shell: SPCC Plating Ni  
2. NOTE: DIMENSIONS MARKED "▼" TO BE CHECKED BY Q.C & IPQC.

X. ±0.35	X.' ±2'	UNITS	mm	<b>雅安科技有限公司</b> <b>ACCURATE INNOTECH INC.</b>			
.X ±0.3	.X' ±1'	MAT'L	SEE NOTE				
.XX ±0.25	.XX'	FINISH	SEE NOTE	DR:	MUYM-105N-4BSS12		
.XXX ±0.15	.XXX'	Q'TY	SEE NOTE	CHKD:	DWG NO.:		
THESE DRAWINGS AND SPECIFICATIONS ARE THE PROPERTY OF ACCURATE INNOTECH INC. AND SHALL NOT BE REPRODUCED, COPIED OR USED IN ANY MANNER WITHOUT THE PRIOR WRITTEN CONSENT OF ACCURATE INNOTECH INC.				APPD:	AII-SS12		
				SCALE	SHEET	REV.	CUSTOMER DRAWING
				1:1	1/1	B	



RoHS  
Compliant  
2002/95/EC

REV	LTR	DESCRIPTION	DATE	REVISER	APPD

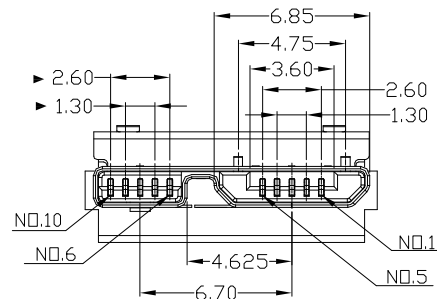
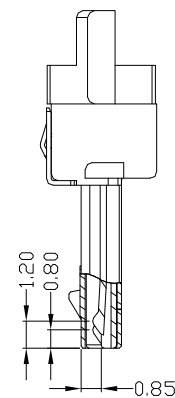
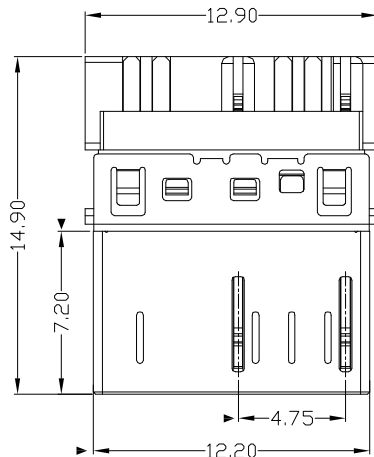
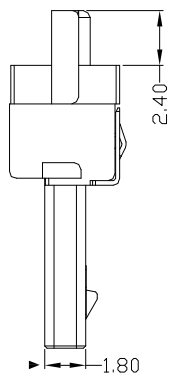
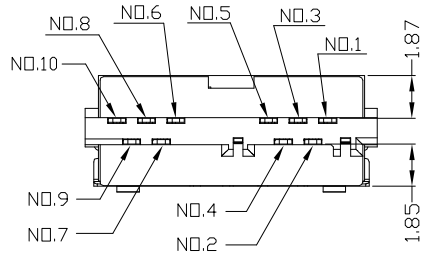

- NOTES:
- ELECTRICAL:
    - VOLTAGE CURRENT RATING: 1AMP, 30V AC;
    - INSULATION RESISTANCE: 100MΩ MIN;
    - CONTACT RESISTANCE: 30mΩ MAX;
    - WITHSTANDING VOLTAGE: 500V AC;
    - OPERATING TEMPERATURE: -40°C TO +85°C.
  - Mechanical:
    - Mating Force: 35N MAX
    - Unmating Force: 10N MIN.
  - NOTE: DIMENSIONS MARKED "▼" TO BE CHECKED BY Q.C & IPQC.

4. PART NO.

MUYM-105N-4BSS12

1Au 1U'  
5Au 15U'  
6Au 30U'

W/WHITE  
B/BLACK  
1PBT  
2PAGT  
3PA9T  
4LCP

Bill of materials:

NO	PARTS	MATERIAL	QTY	FINISHING	UNITS	mm	UNITS	mm	TITLE:	PART NO.:	DR:	DWG NO.:	SCALE	SHEET	REV.	CUSTOMER DRAWING
4	HOOK	STAINLESS STEEL	1	PLATED NICKEL	X. ±0.35	X.' ±2'	MAT'L	SEE NOTE	Micro USB 3.0 B TYPE MALE (半封槽)主体	MUYM-105N-4BSS12	gan 2012/8/3	AII-SS12	1:1	1/1	B	
3	HOUSING SHELL	COPPER ALLOY	1	PLATED NICKEL	.X ±0.3	.X' ±1'	FINISH	SEE NOTE			gan 2012/8/3					
2	HOUSING	LCP/PBT	1	UL94V-0	.XX ±0.25	.XX'	Q'TY	SEE NOTE								
1	TERMINAL	COPPER ALLOY	10	PLATED GOLD/TIN	.XXX ±0.15	.XXX'	<small>THESE DRAWINGS AND SPECIFICATIONS ARE THE PROPERTY OF ACCURATE INNOTECH INC AND SHALL NOT BE REPRODUCED, COPIED OR USED IN ANY MANNER WITHOUT THE PRIOR WRITTEN CONSENT OF ACCURATE INNOTECH INC</small>									
APPD:											APPD:					



RoHS  
Compliant  
2002/95/EC

REV	LTR	DESCRIPTION	DATE	REVISER	APPD

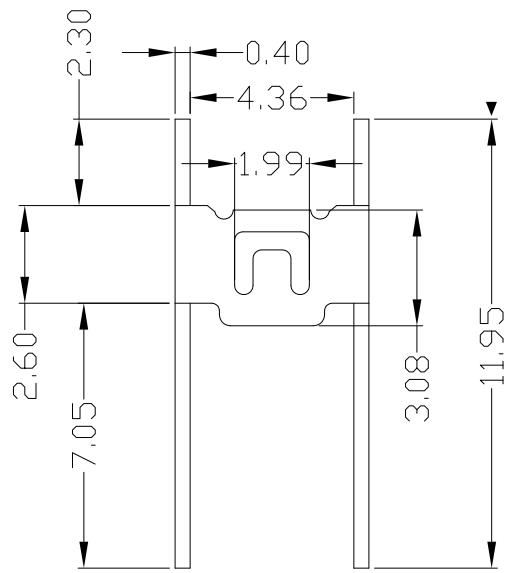
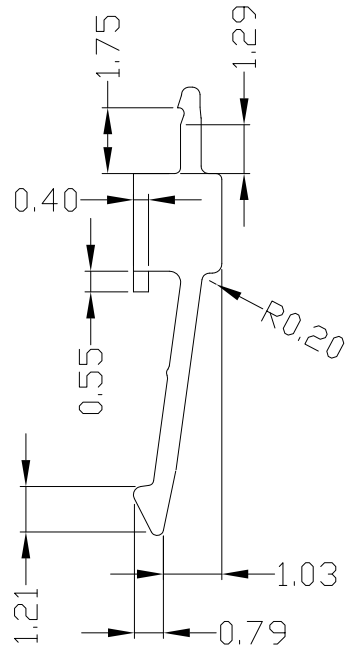
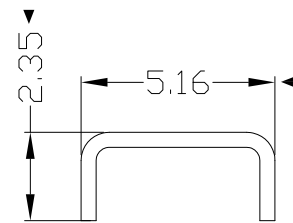

NOTES:  
1.MATERIAL:  
HOOK:STAINLESS STEEL Plating Ni  
2.NOTE:DIMENSIONS MARKED "▼"  
TOBE CHECKED BY Q.C & IPQC.

X. ±0.35	X.* ±2°	UNITS	雅安科技有限公司 ACCURATE INNOTECH INC.			
.X ±0.3	.X* ±1°	MAT'L	TITLE: Micro USB 3.0 B TYPE MALE (半封槽)HOOK		PART NO.: MUYM-105N-4BSS12	
.XX ±0.25	.XX*	SEE NOTE				
.XXX ±0.15	.XXX*	FINISH	DR: gan 2012/8/3		DWG NO.: AII-SS12	
THESE DRAWINGS AND SPECIFICATIONS ARE THE PROPERTY OF ACCURATE INNOTECH INC AND SHALL NOT BE REPRODUCED, COPIED OR USED IN ANY MANNER WITHOUT THE PRIOR WRITTEN CONSENT OF ACCURATE INNOTECH INC						
Q'TY			CHKD: gan 2012/8/3		SCALE	SHEET
			APPD:		1:1	1/1
					REV.	CUSTOMER DRAWING
					B	