

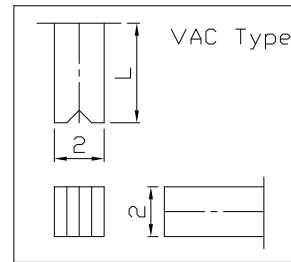

RoHS
Compliant
2002/95/EC

REV.	ECN.	NO.	APPD.

DIMENSIONS

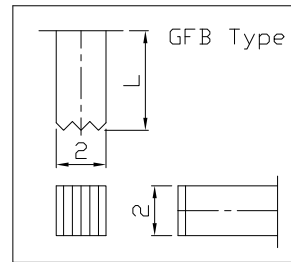
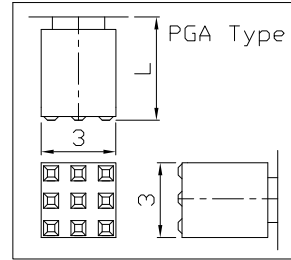
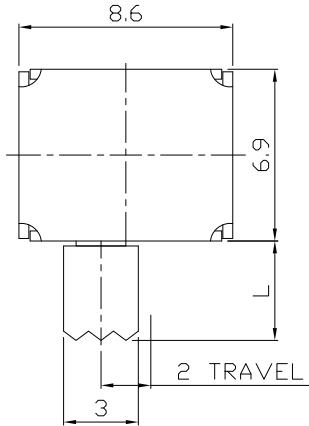

MODEL CODE

SK-22D09-GEI

Knob Type

GEI
PGA
GFB
VAC

L(mm)

~

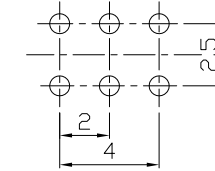

P.C.B LAYOUT
BOTTOM VIEW

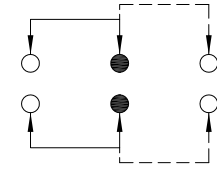

CIRCUIT DIAGRAM

ELECTRO-MECHANICAL CHARACTERISTICS

Refer to additional specifications

RATING	0.3A 50V DC
CIRCUIT	2P2T
CONTACT RESISTANCE	100mΩ MAX.
TIMING	NON-SHORTING
TRAVEL	2mm
OPERATING FORCE	250±100gf
OPERATING LIFE(cycles)	10,000

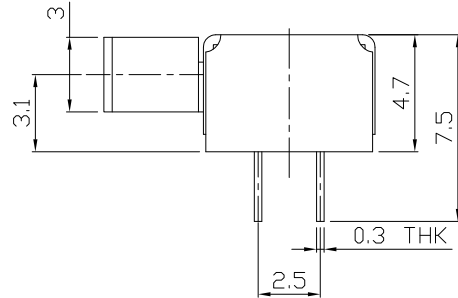
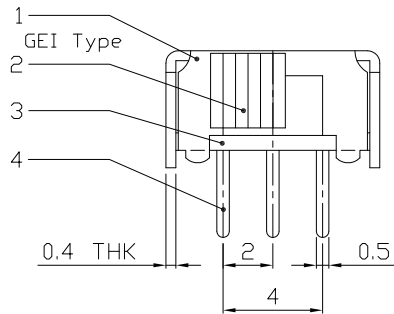

8							
7							
6	SPRING PLATE	PBS STRIP	1	NATURAL			
5	CONTACT CLIP	PBS STRIP	2	Ag PLATED			
4	TERMINAL	BRASS STRIP	6	Ag PLATED			
3	BASE	PHENOLIC RESIN	1	NATURAL			
2	KNOB	POM	1	BLACK			
1	FRAME	STEEL STRIP	1	Ni PLATED			
NO.	PARTS	MATERIAL	Q'TY	FINISHING			

WITHIN 1.5mm: ±0.1mm
OVER 1.5mm: ±0.2mm

UNITS mm

MAT'L SEE NOTE

FINISH SEE NOTE

Q'TY

THESE DRAWINGS AND SPECIFICATIONS ARE THE PROPERTY OF ACCURATE INNOTECH INC AND SHALL NOT BE REPRODUCED, COPIED OR USED IN ANY MANNER WITHOUT THE PRIOR WRITTEN CONSENT OF ACCURATE INNOTECH INC.

雅安科技有限公司
ACCURATE INNOTECH INC.

TITLE: SLIDE SWITCH / HORIZONTAL

PART NO.: SK-22D09

DR: Ricky 2016/06/24

DWG NO.: ADL-22D09

CHKD: Ricky 2016/06/24

APPD:

SCALE	SHEET	REV.	CUSTOMER
4:1	1/1	A	DRAWING