

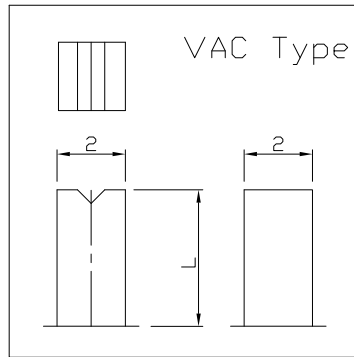

RoHS Compliant  
2002/95/EC

REV.	ECN.	NO.	APPD.

DIMENSIONS

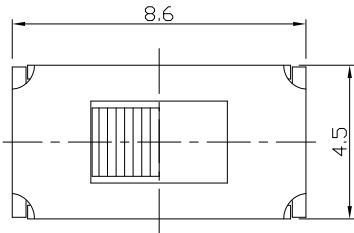

MODEL CODE

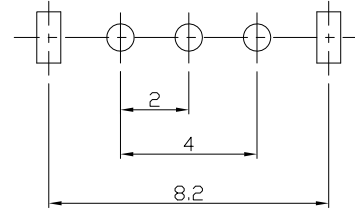
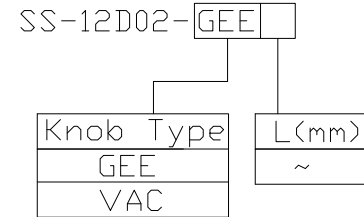

P.C.B LAYOUT  
BOTTOM VIEW

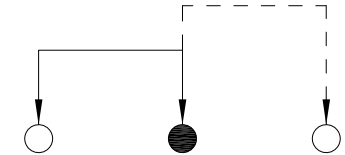

CIRCUIT DIAGRAM

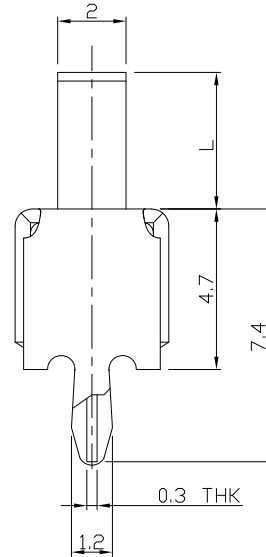
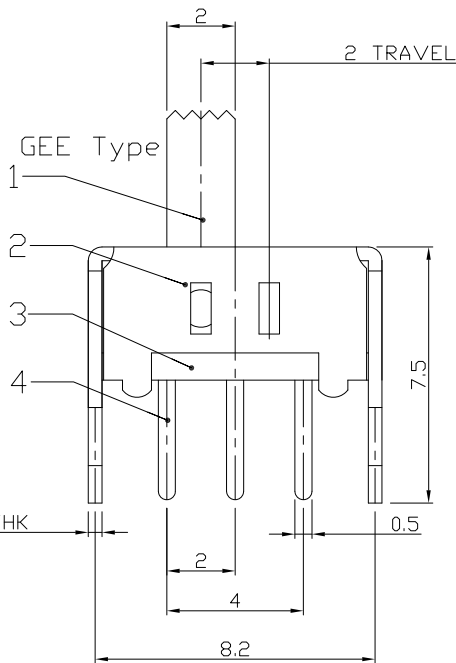

ELECTRO-MECHANICAL CHARACTERISTICS  
Refer to additional specifications

RATING	DC50V 0.3A
CIRCUIT	1P2T
CONTACT RESISTANCE	100mΩ MAX.
TIMING	NON-SHORTING
TRAVEL	2mm
OPERATING FORCE	250±100gf
OPERATING LIFE(cycles)	10,000

8					
7					
6	SPRING PLATE	PBS STRIP	1	NATURAL	
5	CONTACT CLIP	PBS STRIP	1	Ag PLATED	
4	TERMINAL	BRASS STRIP	3	Ag PLATED	
3	BASE	PHENOLIC RESIN	1	NATURAL	
2	FRAME	STEEL STRIP	1	Ni PLATEFD	
1	KNOB	POM	1	BLACK	
NO.	PARTS	MATERIAL	Q'TY	FINISHING	

WITHIN 1.5mm: ±0.1mm  
OVER 1.5mm: ±0.2mm

UNITS mm

MAT'L  
SEE NOTE

FINISH  
SEE NOTE

Q'TY

THESE DRAWINGS AND SPECIFICATIONS ARE THE PROPERTY OF ACCURATE INNOTECH INC AND SHALL NOT BE REPRODUCED, COPIED OR USED IN ANY MANNER WITHOUT THE PRIOR WRITTEN CONSENT OF ACCURATE INNOTECH INC.

雅安科技有限公司  
ACCURATE INNOTECH INC.

TITLE: SLIDE SWITCH / VERTICAL  
PART NO.: SS-12D02

DR: Ricky 2015/05/19  
DWG NO.: ADL-12D02

CHKD: Ricky 2015/05/19

APPD:

SCALE	SHEET	REV.	CUSTOMER DRAWING
4:1	1/1	A	