

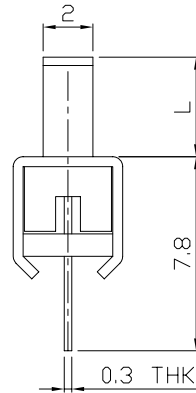

RoHS
Compliant
2002/95/EC

| REV. | ECN. | NO. | APPD. |
|------|------|-----|-------|
| | | | |
| | | | |
| | | | |

DIMENSIONS

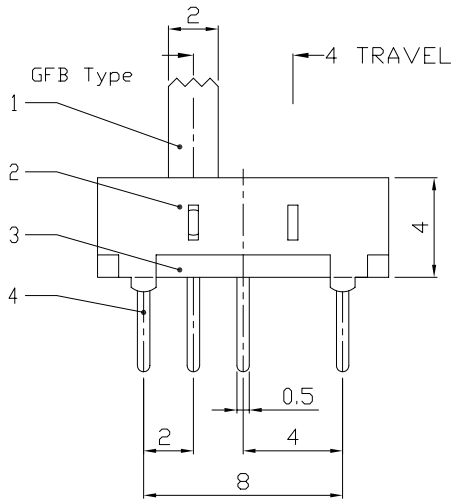
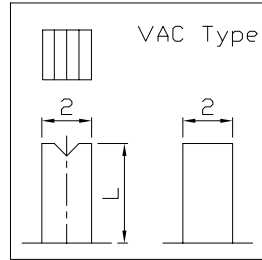
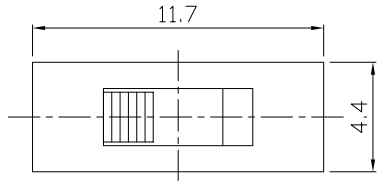

MODEL CODE

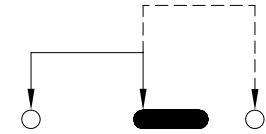
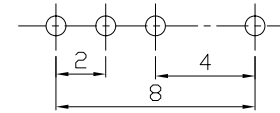
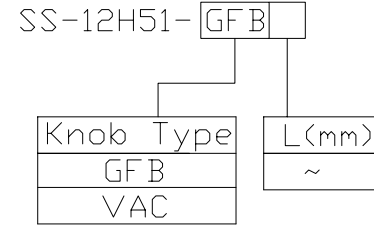

P.C.B LAYOUT
BOTTOM VIEW

CIRCUIT DIAGRAM

ELECTRO-MECHANICAL CHARACTERISTICS

Refer to additional specifications

| | |
|------------------------|---------------|
| RATING | 0.3A 50V DC |
| CIRCUIT | 1P2T |
| CONTACT RESISTANCE | 30mΩ MAX. |
| TIMING | NOT SPECIFIED |
| TRAVEL | 4mm |
| OPERATING FORCE | 200±100gf |
| OPERATING LIFE(cycles) | 10,000 |

| | | | | | |
|-----|--------------|----------------|------|--------------------------|--|
| 8 | | | | | |
| 7 | | | | | |
| 6 | SPRING PLATE | SUS | 2 | NATURAL | |
| 5 | CONTACT CLIP | PBS C5210R-EH | 1 | Ag CLAD | |
| 4 | TERMINAL | BRASS STRIP | 4 | Ag PLATED OVER Ni PLATED | |
| 3 | BASE | PHENOLIC RESIN | 1 | NATURAL | |
| 2 | FRAME | STEEL STRIP | 1 | Ni PLATED | |
| 1 | KNOB | POM | 1 | BLACK | |
| NO. | PARTS | MATERIAL | Q'TY | FINISHING | |

WITHIN 1.5mm: ±0.1mm
OVER 1.5mm: ±0.2mm

UNITS mm

MAT'L SEE NOTE

FINISH SEE NOTE

Q'TY

THESE DRAWINGS AND SPECIFICATIONS ARE THE PROPERTY OF ACCURATE INNOTECH INC AND SHALL NOT BE REPRODUCED, COPIED OR USED IN ANY MANNER WITHOUT THE PRIOR WRITTEN CONSENT OF ACCURATE INNOTECH INC.

雅安科技有限公司
ACCURATE INNOTECH INC.

| | |
|-----------------------------------|--|
| TITLE: SLIDE SWITCH / VERTICAL | PART NO.: SS-12H51 |
| DR: <i>Ricky</i> 2015/06/09 | DWG NO.: ADJ-12H51 |
| CHKD: <i>Ricky</i> 2015/06/09 | SCALE SHEET REV. CUSTOMER 4:1 1/1 A DRAWING |
| APPD: | |