

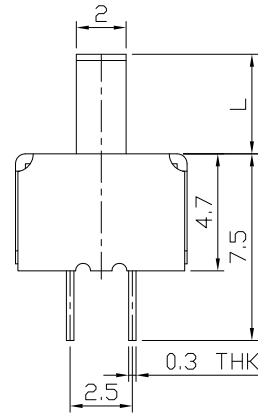

RoHS
Compliant
2002/95/EC

REV.	ECN.	NO.	APPD.

DIMENSIONS

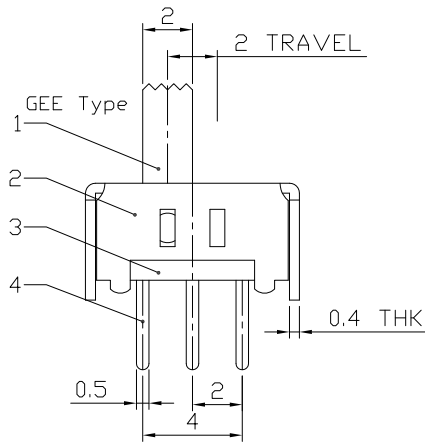
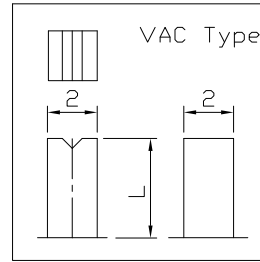
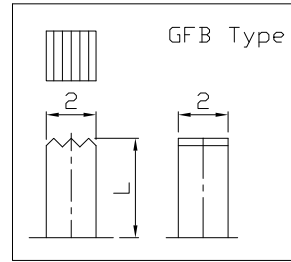
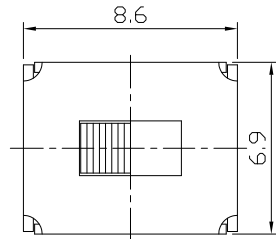

MODEL CODE

SS-22D02-GEE

Knob Type
GEE
GFB
VAC

L(mm)
~

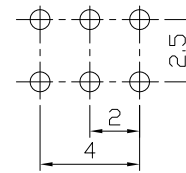

P.C.B LAYOUT
BOTTOM VIEW

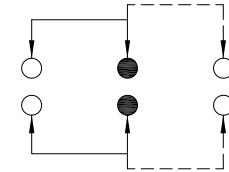

CIRCUIT DIAGRAM

ELECTRO-MECHANICAL CHARACTERISTICS

Refer to additional specifications

RATING	0.3A 50V DC
CIRCUIT	2P2T
CONTACT RESISTANCE	100mΩ MAX.
TIMING	NON-SHORTING
TRAVEL	2mm
OPERATING FORCE	250±100gf
OPERATING LIFE(cycles)	10,000

8					
7					
6	SPRING PLATED	PBS STRIP	1	NATURAL	
5	CONTACT CLIP	PBS STRIP	1	Ag PLATED	
4	TERMINAL	BRASS STRIP	6	Ag PLATED	
3	BASE	PHENOLIC RESIN	1	NATURAL	
2	FRAME	STEEL STRIP	1	Ni PLATED	
1	KNOB	POM	1	BLACK	
NO.	PARTS	MATERIAL	Q'TY	FINISHING	

WITHIN 1.5mm: ±0.1mm
OVER 1.5mm: ±0.2mm

UNITS mm

MAT'L SEE NOTE

FINISH SEE NOTE

Q'TY

THESE DRAWINGS AND SPECIFICATIONS ARE THE PROPERTY OF ACCURATE INNOTECH INC AND SHALL NOT BE REPRODUCED, COPIED OR USED IN ANY MANNER WITHOUT THE PRIOR WRITTEN CONSENT OF ACCURATE INNOTECH INC.

雅安科技有限公司 ACCURATE INNOTECH INC.			
TITLE: SLIDE SWITCH / VERTICAL		PART NO.: SS-22D02	
DR: <i>Ricky</i> 2015/05/26		DWG NO.: ADL-22D02	
CHKD: <i>Ricky</i> 2015/05/26		SCALE	SHEET
APPD:		4:1	1/1
		REV.	CUSTOMER DRAWING
		A	