

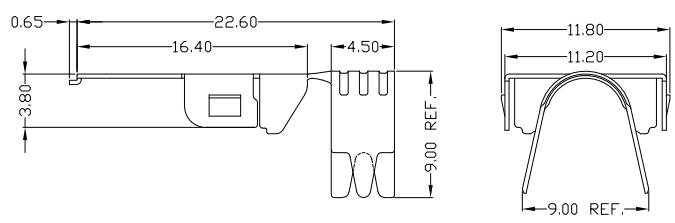

RoHS Compliant  
2002/95/EC

REV	LTR	DESCRIPTION	DATE	REVISER	APPD

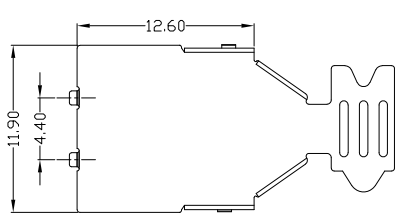
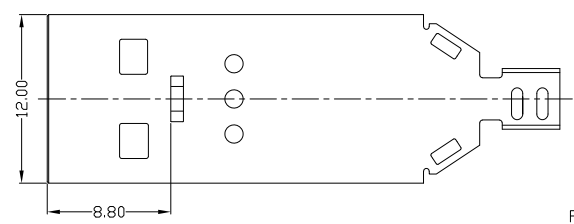
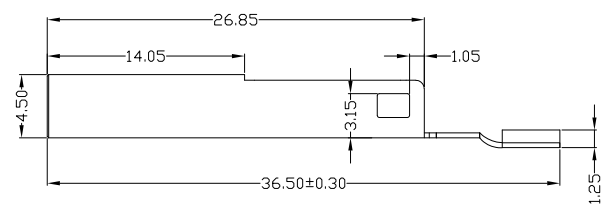
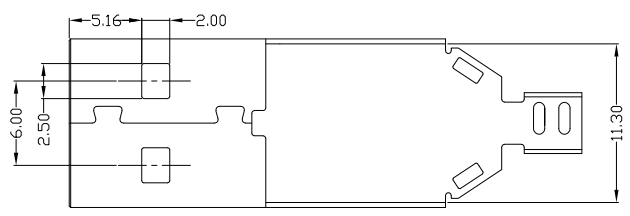

FRONT SHELL  
BACK SHELL

CONNECTOR

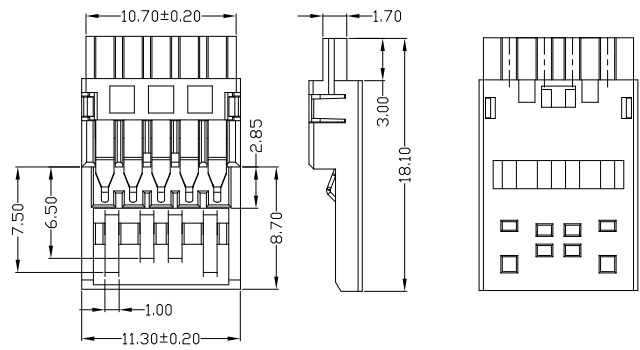
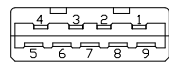

NOTES:

- ELECTRICAL:
  - VOLTAGE CURRENT RATING: 1.5AMP, 30V AC;
  - INSULATION RESISTANCE: 1000MΩ MIN;
  - CONTACT RESISTANCE: 30mΩ MAX;
  - WITHSTANDING VOLTAGE: 500V AC;
  - OPERATING TEMPERATURE: -55°C TO +85°C.
- Mechanical:
  - Mating Force: 35N MAX
  - Unmating Force: 10N MIN.
- DIMENSIONS MARKED "▼"  
TO BE CHECKED BY Q.C & IPQC.

4. PART NO.

USAM-09\*N-1BLSU33

- 1: Au 1U\*
- 5: Au 15U\*
- 6: Au 30U\*
- ▼: WHITE
- B: BLACK
- BL: BLUE
- 1: PBT
- 2: PA6T
- 3: PA9T
- 4: LCP

Bill of materials:

NO	PARTS	MATERIAL	QTY	FINISHING	X. ±0.35	X.' ±2'	UNITS	mm	雅安科技有限公司 ACCURATE INNOTECH INC.			
4	HOUSING	PBT+30%GF	1	UL94V-0	.X ±0.3	.X' ±1'	MAT'L	SEE NOTE	TITLE: USB AM 3.0 手工焊线 普通款三件套OD6.0 PART NO.: USAM-09XN-1BLSU33			
3	SHELL	SPCC	2	PLATED NICKEL	.XX ±0.25	.XX'	SEE NOTE	DR: Ricky 2019/2/21				
2	TERMINAL(4P)	COPPER ALLOY	4	PLATED GOLD/TIN	.XXX ±0.15	.XXX'	FINISH	SEE NOTE	CHKD: Ricky 2019/2/21			
1	TERMINAL(5P)	COPPER ALLOY	5	PLATED GOLD/TIN	THESE DRAWINGS AND SPECIFICATIONS ARE THE PROPERTY OF ACCURATE INNOTECH INC AND SHALL NOT BE REPRODUCED, COPIED OR USED IN ANY MANNER WITHOUT THE PRIOR WRITTEN CONSENT OF ACCURATE INNOTECH INC							
NO	PARTS	MATERIAL	QTY	FINISHING								

