

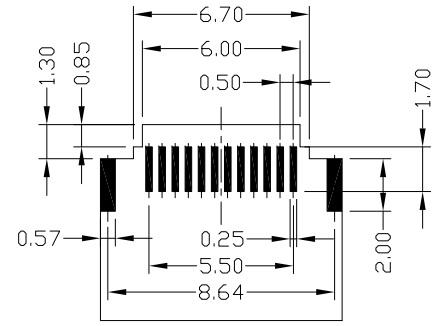

RoHS  
Compliant  
2002/95/EC

REV.	ECN.	NO.	APPD.

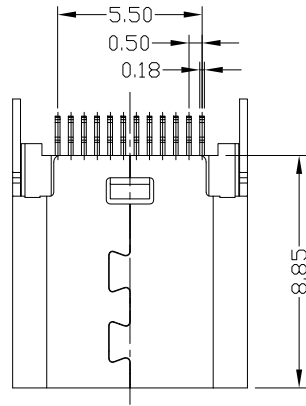
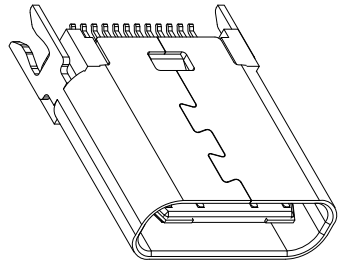

RECOMMENDED P.C.B. LAYOUT  
TOLERANCE UNSPECIFIED ±0.05mm

正/反面 LAYOUT 一样  
板厚: T=1.00mm

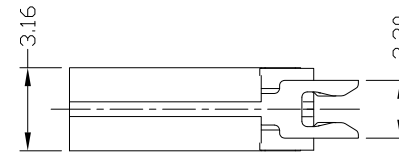
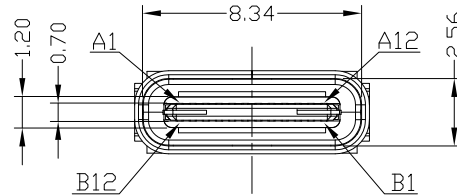
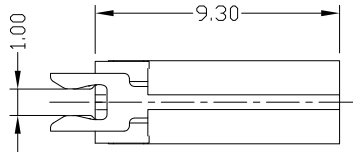

A1	GND	B12	GND
A2	SSTXP1	B11	SSRXP1
A3	SSTXN1	B10	SSRXN1
A4	VBUS	B9	VBUS
A5	CC1	B8	SBU2
A6	DP1	B7	DN2
A7	DN1	B6	DP2
A8	SBU1	B5	CC2
A9	VBUS	B4	VBUS
A10	SSRXN2	B3	SSTXN2
A11	SSRXP2	B2	SSTXP2
A12	GND	B1	GND
PIN	SIGNAL NAME	PIN	SIGNAL NAME

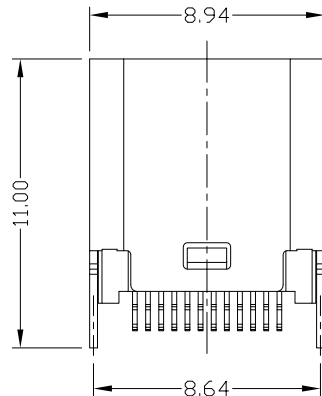

NOTES:

- ELECTRICAL:
  - CURRENT RATING: 3.0 AMP;
  - INSULATION RESISTANCE: 100MΩ MIN;
  - CONTACT RESISTANCE: 40mΩ MAX;
  - WITHSTANDING VOLTAGE: 100V AC;
  - OPERATING TEMPERATURE: -30°C TO +80°C.
- Mechanical:
  - Mating Force: 20N MAX
  - Unmating Force: 8N MIN.
- DIMENSIONS MARKED "▼" TO BE CHECKED BY Q.C & IPQC.

4. PART NO.

USCF-24\*N-4BH61  
 1: WHITE  
 2: BLACK  
 1: Au 1U\*  
 2: Au 3U\*  
 5: Au 15U\*  
 6: Au 30U\*  
 1: PBT  
 2: PA6T  
 3: PA9T  
 4: LCP

Bill of materials:

5	SHRAPNEL	STAINLESS STEEL	1		X. ±0.35	X.' ±2'	UNITS	雅安科技有限公司 ACCURATE INNOTECH INC.				
4	HOOK	STAINLESS STEEL	2		.X ±0.3	.X' ±1'	MAT'L	TITLE: USB Type-C/F 180夹板1.0 长9.3				
3	SHELL	STAINLESS STEEL	1	PLATED NICKEL/TIN	.XX ±0.25	.XX'	SEE NOTE	PART NO.: USCF-24*N-4BH61				
2	TERMINAL	COPPER ALLOY	24	PLATED GOLD/TIN	.XXX ±0.15	.XXX'	SEE NOTE	DR: gan 2017/8/4				
1	HOUSING	LCP+30%GF	1	UL94V-0	THESE DRAWINGS AND SPECIFICATIONS ARE THE PROPERTY OF ACCURATE INNOTECH INC AND SHALL NOT BE REPRODUCED, COPIED OR USED IN ANY MANNER WITHOUT THE PRIOR WRITTEN CONSENT OF ACCURATE INNOTECH INC.			DWG NO.: AII-H61				
NO	PARTS	MATERIAL	QTY	FINISHING				Q'TY	CHKD: gan 2017/8/4			
								APPD:	SCALE	SHEET	REV.	CUSTOMER DRAWING
									1:1	1/1	B	